

DIGISTAT PROGRAMMABLE 24 HOUR ROOM THERMOSTAT SYSTEM

Radio frequency controlled programmable room thermostat.

LARGE RECEIVER: 24CDi, 26CDi Xtra, 28CDi, 35CDi Mk I and 35CDi Mk II

SMALL RECEIVER: 24i Junior, 28i Junior and Si Mk II

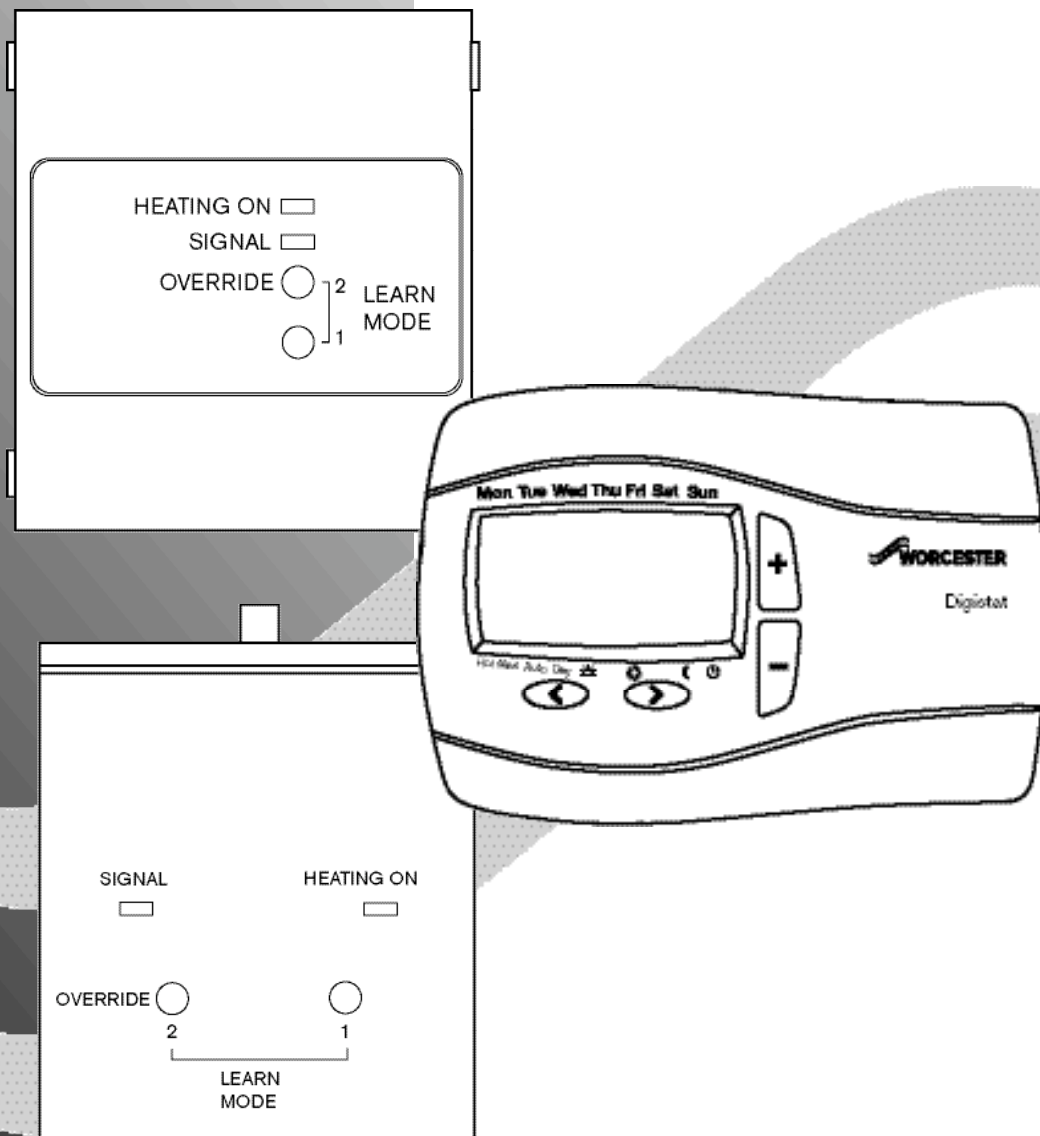

WORCESTER, BOSCH GROUP:

TECHNICAL	08705 266241
SERVICE	08547 256206
SPARES	01905 752571
LITERATURE	01905 752556
TRAINING	01905 752526
SALES	01905 752640
WEBSITE	worcester-bosch.co.uk

SYMBOLS



Domestic Hot Water



Radio Frequency (RF) Transmitter

PLEASE READ THESE INSTRUCTIONS CAREFULLY BEFORE STARTING

THESE INSTRUCTIONS ARE APPLICABLE TO THE WORCESTER BOSCH MODEL(S) STATED ON THE FRONT COVER OF THIS MANUAL ONLY AND MUST NOT BE USED WITH ANY OTHER MAKE OR MODEL

THESE INSTRUCTIONS APPLY IN THE UK ONLY AND SHOULD BE FOLLOWED EXCEPT FOR ANY STATUTORY OBLIGATION

IF YOU ARE IN ANY DOUBT CONTACT WORCESTER BOSCH TECHNICAL HELPLINE

THIS ACCESSORY MUST BE FITTED BY A COMPETENT PERSON. FAILURE TO COMPLY COULD LEAD TO PROSECUTION.

LEAVE THESE INSTRUCTIONS WITH THE USER OR AT THE APPLIANCE.

ABBREVIATIONS

CH	=	Central Heating
DHW	=	Domestic Hot Water
RF	=	Radio Frequency
DLS	=	Daylight Saving
BST	=	British Summer Time
GMT	=	Greenwich Mean Time
C	=	Celsius (Centigrade)
IP	=	Ingress Protection
V	=	Volt
m	=	metre
mA	=	milliAmpere

DEFINITIONS (DLS/BST)

Summer period begins: Last Sunday in March at 1:00 am GMT (Clocks are put forward by 1 hour)

Summer period ends: Last Sunday in October at 2:00 am BST (Clocks put back 1 hour)

TECHNICAL DATA1

GENERAL INFORMATION2

 PROGRAMMABLE THERMOSTATS2

DIGISTAT OPTIMISER3

 OPERATING CONTROLS3

 PRE-PROGRAMMED SETTINGS4

 PROGRAMMABLE SETTINGS4

 ADJUSTING TIMES AND TEMPERATURES4

 USER OPTIONS6

RECEIVER9

 OPERATIONAL CONTROLS9

INSTALLATION10

 RECEIVER10

 DIGISTAT11

 SETTING THE RF LINK12

 DIGISTAT INSTALLER OPTIONS13

MAINTENANCE15

TECHNICAL DATA

DESCRIPTION	UNITS	Receiver	Digistat Transmitter
Dimensions	mm	--	137 x 96.5 x 31.3
Electrical supply	V	24	3
Radio frequency	MHz	433	433
Radio signal range	The range may be affected by the composition / density and number of walls between the Digistat RF and receiver. 30 metres typically, through two internal plasterboard walls and a ceiling. 26 metres typically, through three internal plasterboard walls and a ceiling. 17 metres typically, through two internal plasterboard walls a ceiling and one external cavity wall. These distances are provided for guidance only, many factors can affect the range of the transmitter, including metal pipework, appliances and even furniture.		
Temperature range	°C	5 to 32	5 to 32
Ambient operating temperature	°C	0 to +50	0 to +40
Humidity operating range	% non condensing up to 45°C	30 to 95	25 to 90
Class of operation		II	--
Degrees of protection	IP	24	30
Accuracy at 25°C	sec/day	--	-
Battery life (with alkaline batteries)	years	N/A	approx. 2
Battery back up time and date	years min.	--	10
Shortest switching period	minutes	--	1
Hot water pre-heat settings	number	--	--
Central heating settings	number	--	6
Hot water and Central heating programs	days	--	7

EC Directives:

European Union Law Directive 2000/84/EC

Low Voltage Directive (2006/95/EC)

Electro-Magnetic Compatibility Directive (89/336/EEC)

EC Marking Directive (93/68/EEC)

STANDARD PACKAGE:

RF receiver

Remote RF transmitter

Screws (x2)

Wall Plugs (x2)

Instructions

Batteries (x2) AA Alkaline

What is a programmable room thermostat?

A programmable room thermostat is both a programmer and a room thermostat. A programmer allows you to set 'On' and 'Off' time periods to suit your own lifestyle.

A room thermostat works by sensing the air temperature, switching on the heating when the air temperature falls below the thermostat setting, and switching it off once this set temperature has been reached.

So, a programmable room thermostat lets you choose what times you want the heating to be on, and what temperature it should reach while it is on. It will allow you to select different temperatures in your home at different times of the day (and days of the week) to meet your particular needs.

Turning a programmable room thermostat to a higher setting will not make the room heat up any faster. How quickly the room heats up depends on the design of the heating system, for example, the size of boiler and radiators.

Neither does the setting affect how quickly the room cools down.

Turning a programmable room thermostat to a lower setting will result in the room being controlled at a lower temperature, and saves energy.

The way to set and use your programmable room thermostat is to find the lowest temperature settings that you are comfortable with at the different times you have chosen, and then leave it alone to do its job.

The best way to do this is to set low temperatures first, say 18°C, and then turn them up by one degree each day until you are comfortable with the temperatures.

You won't have to adjust the thermostat further. Any adjustments above these settings will waste energy.

If your heating system is a boiler with radiators, there will usually be only one programmable room thermostat to control the whole house.

But you can have different temperatures in individual rooms by installing thermostatic radiator valves (TRVs) on individual radiators.

If you don't have TRVs, you should choose a temperature that is reasonable for the whole house. If you do have TRVs, you can choose a slightly higher setting to make sure that even the coldest room is comfortable, then prevent any overheating in other rooms by adjusting the TRVs.

Programmable room thermostats need a free flow of air to sense the temperature, so they must not be covered by curtains or blocked by furniture. Nearby fires, televisions, wall or table lamps may prevent the thermostat from working properly.

Digistat Programmable Thermostat

The Digistat Programmer has factory set programs for ON/OFF periods for central heating which are described on the following pages. These factory installed settings can be used without any further programming.

Clock Setting

The Digistat Programmable Thermostat is fitted with a real-time clock, which is pre-set at the factory. You will not have to set the time.

A special feature of this real-time clock is to automatically update the time during the summer/winter time change removing the need to manually alter the clock.

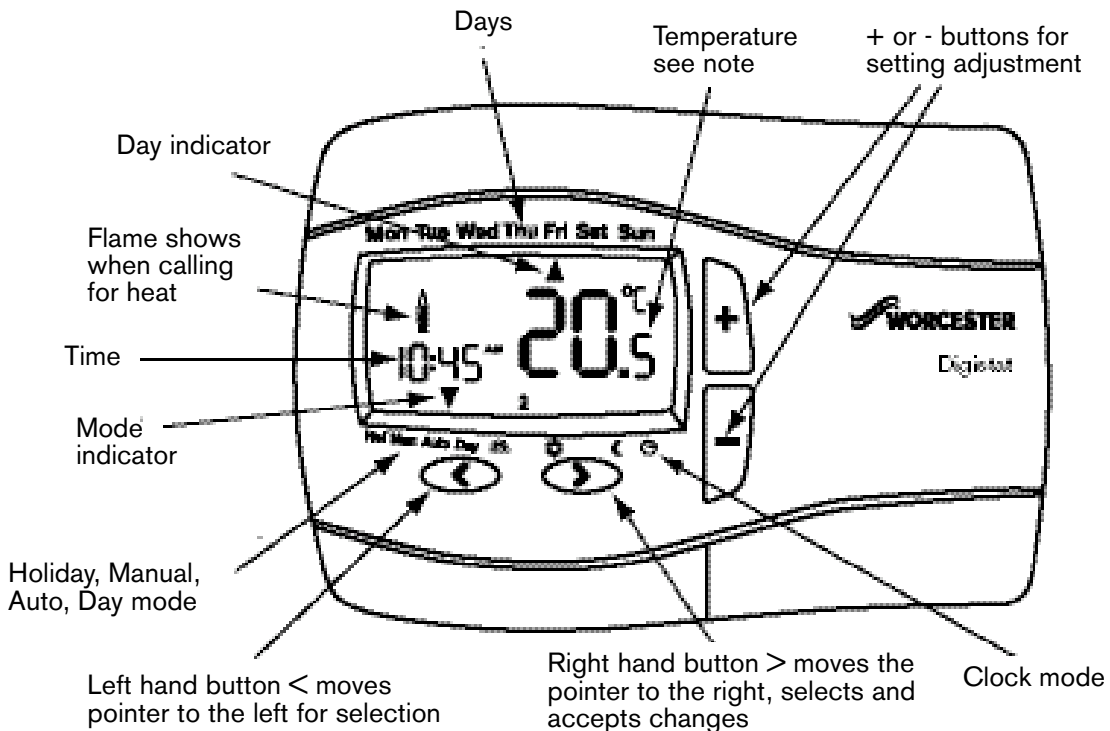

NOTE: The temperature displayed is actual room temperature unless adjusting the + or - button when the set temperature is displayed. Once adjustment is complete and after a 5 second delay the display will return to the actual room temperature.

General Operation

With the unit in Auto mode (the small arrow to bottom of screen will point to Auto) the temperature can be changed for a short time by using the + or - buttons. Changing the temperature in this way will keep the Programmer set to your new temperature until the next pre-programmed event (at which time it will revert to programmed temperature). The temperature you are setting will flash on the screen. Once temperature is set, the unit will revert to showing the current temperature. The indicator will show on the screen if the heating is turned on.

DIGISTAT
PRE-PROGRAMMED SETTINGS

The Digistat Programmer

This is a programmable thermostat 24-Hour product (the same program for every day of the week) which allows you to set up to 6 time and temperature events per day.

Pre-set Program 1

The following default settings are pre-programmed for your convenience:

Every day

Event	1	2	3	4	5	6
Time	06:30	08:30	12:00	14:00	16:30	22:30
Temp.	20	16	16	16	21	7

As shown, at 06:30, the heating will come on to raise the temperature to 20°C. At 08:30, the temperature set point is dropped from 20°C down to 16°C, it stays at 16°C throughout the day, until 16:30 when the temperature increases to 21°C. The temperature then drops down to a night-set-back temperature of 7°C until 06:30 when the cycle repeats for the next day.

To switch the thermostat OFF:

Press the + and – simultaneously for 5 seconds until the OFF is displayed.

The thermostat and heating system will now be OFF unless the temperature in the controlled space falls below 7°C, the frost protection set point.

Please note this does not affect the operation of the domestic hot water where provided.

To switch ON the thermostat, press any key to return to auto mode.

PROGRAMMABLE SETTINGS
ADJUSTING TIMES & TEMPERATURES

Digistat Programmer - 24 hour operation

1. With the product operating as normal in Auto mode press > twice until display is flashing as shown. The time will be flashing, use the + or - buttons to adjust the 1st time as required.

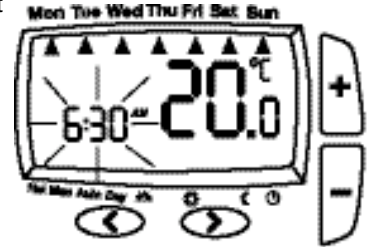

2. Once the time has been set press > to confirm and use + or - button to adjust required temperature (temperature *shown flashing)



(* small 1 in lower half of screen shows time period is being set.
e.g. 1=1st period, 2 = 2nd period etc)

3. Once the temperature has been set press > to confirm and move to next time and temperature periods to be adjusted confirming changes by pressing > button. (max 6 periods).

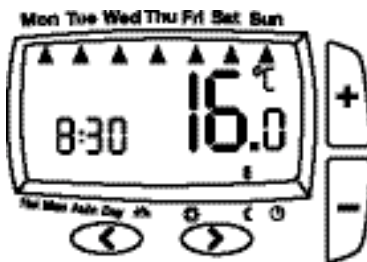

4. To exit press < or > until you return to auto mode with the bottom arrow pointing to auto (as shown).

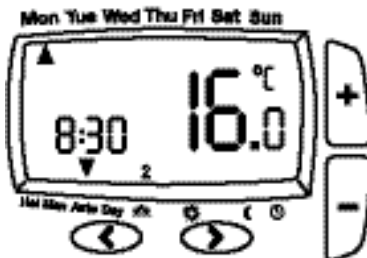

PROGRAMMABLE SETTINGS
ADJUSTING TIMES & TEMPERATURES

To change temperature for a short period (Override):

1. Press + or - buttons to adjust set temperature. Set temperature shown flashing

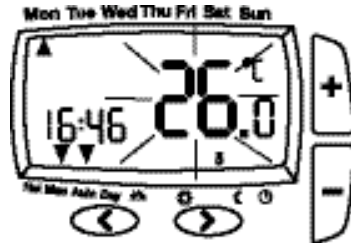

2. After 5 seconds will start controlling at selected set point but displays actual room temperature. Two chevrons indicates override mode.

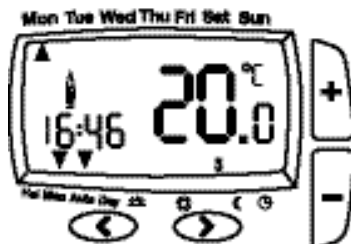

3. To exit override press > once or wait until next change in the pre-set program.

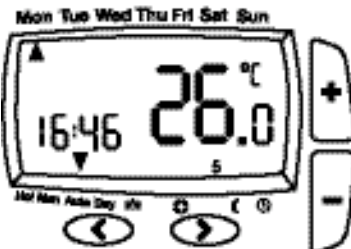

To set a constant room temperature (Manual mode):

1. Press > once, the display shows temperature flashing (eg 20°C)

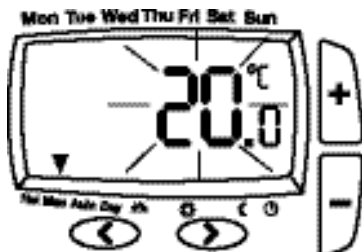

2. Press + or - buttons to adjust the temperature as required. The temperature will stop flashing after 5 seconds and start controlling at this temperature.

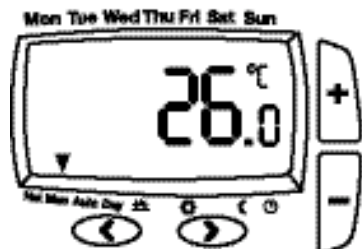

3. Press > once, to return to auto mode.

To set holiday mode:

1. Press < twice, the display shows time flashing
Time periods between 1 to 23(Hr) hours and 1 to 199(d) days can be set.

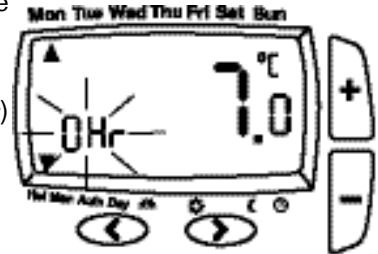

2. Press + or - buttons to adjust the count down time as required. Press > once to confirm, the display will show temperature flashing.

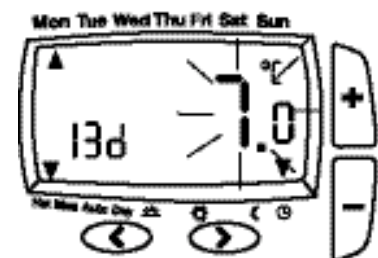

3. Press + or - buttons to adjust temperature and press > to start holiday count down time. Alternatively after 10 seconds the temperature will stop flashing and holiday count down time will start. Display shows count down time and ambient room temperature.



4. To exit the holiday mode press the < or > once, to return to auto.



User Options

User Options (shown in table below) can be accessed from Auto or Man by pressing < and > simultaneously for 3 seconds.

Once you have accessed the User Options Menu press > to scroll through selectable options.

The settings for each option can be changed by pressing + or - as required.

Pressing > accepts the change and moves to the next option.

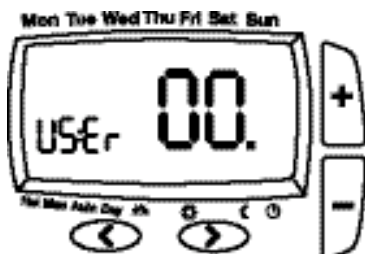

NOTE: To exit User Options press < and > simultaneously for 3 seconds.

Alternatively, not pressing any buttons for 2 minutes will cause the Programmer to return to Auto.

This figure opposite shows option "01 24" (24 hour clock).

Only options that have been accepted by pressing > will be changed.



Option	Description of Option	Min	Max	Default
01	Change clock 12h/24h	12	24	24
02	Change pre-set program	1	3	1
03	Change number of program events per day	2,4 or 6		6
04	Switch on/off daylight saving time change	On	Off	On
05	Adjust date and time	Factory set		
06	Change temperature offset °C	-5	5	0
07	Restore pre-set program	On	Off	Off
08	Disable OFF function	On	Off	On
09	Access protection lock	On	Off	Off

Option 01 Change from 24hr to 12hr clock.

Enter user options, select option 01 and use + and - keys to select desired option, 12 = 12hr and 24 = 24hr. Press > to accept change.

Option 02 Change to program 1, 2 or 3.

Enter user options, select option 02 and use + and - keys to select desired program 1, 2 or 3.

1 = program 1, 2 = program 2 and 3 = program 3. Press > to accept change.

Preset programs 2 and 3 are shown below:

Pre-set Program 2 (Home for lunch)

24 hour

Event	1	2	3	4	5	6
Time	6:30	8:30	12:00	14:00	16:30	22:30
Temperature	21	16	21	16	21	10

At 06:30 the heating raises the temperature to 21°C. At 08:30, the temperature set point is dropped to 16°C, until 12:00 when the heating raises the temperature to 21°C. The temperature stays at 21°C until 14:00 when it drops to 16°C. At 16:30 the heating raises the temperature to 21°C where it stays until 22:30 when the temperature drops down to a setback temperature of 10°C until 06:30 when the cycle repeats the next day.

Pre-set Program 3 (Home Worker)

24 hours

Event	1	2	3	4	5	6
Time	6:00	8:30	12:00	14:00	17:30	22:30
Temperature	21	19	21	19	21	16

As you can see, at 06:00, the heating will come on to raise the temperature to 21°C.

At 08:30, the temperature set point is dropped to 19°C, it stays at 19°C until 12:00 when the heating comes on to raise the temperature to 21°C. The temperature stays at 21°C until 14:00 when it drops to 19°C. At 17:30 the heating comes on to raise the temperature to 21°C where it stays until 22:30 when the temperature drops down to a setback temperature of 16°C until 06:00 when the cycle repeats the next day.

Option 03 How to change the number of program events per day.

Enter user options, select option 03 and use + and - keys to select option. 2 = 2 time / temp events per day, 4 = 4 time / temp events per day and 6 = 6 time / temp events per day. Press > to accept change.

Option 04 How to switch on/off the automatic summer / winter time change.

Twice a year the actual time is automatically changed to keep it in line with the summer / winter time change. Default setting is On.

If you wish to disable / enable this feature enter user options, select option 04 and press - or + key to display Off or On as desired. Press > to accept change.

Date and time setting.

The DT10RF Programmer/Optimising Programmer comes with a pre-set clock, which also automatically adjusts for daylight saving time changes. It is activated automatically on 1st installation. There should be no need to change these settings, however, should you wish to, it can be done in Option 05.

Option 05 How to adjust date and time.

Enter user options, select option 05



To change the year press > once

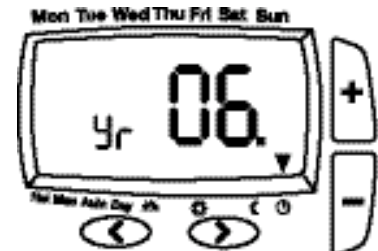

To change the month press > again



To change the day press > again



To change the time press > again

Once you have selected your required display, to adjust press + or - and > to accept change.

To select option 06 press > until option 06 display is shown

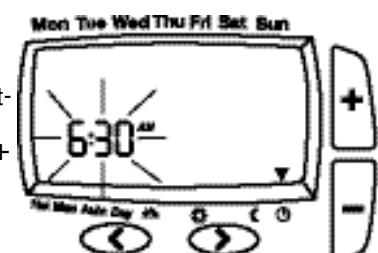

NOTE: Option 5 must be completed before attempting option 6

Option 06 How to change temperature offset.

The temperature displayed on the thermostat may not match that of other temperature measuring devices in the controlled space, because of its location.

The displayed temperature may be offset to bring it in line with other devices.

To adjust the temperature, enter the user options, select option 06.

The temperature may be offset by +/- 5 degrees by pressing the + and - keys. Press > to accept the desired change.

Option 07 How to restore the built in time temperature programs.

NOTE: Enabling this function will lose any user changes to the preset programs.

Enter user options, select option 07 and use + and - keys to select desired option. Off = current programs retained. On = restore factory program settings. Press > to select the desired change.

The option 07 display automatically reverts back to off.

Option 08 How to disable the OFF function.

To disable the OFF function, enter user options, select option 08 and use + or - keys to select Off. Press > to accept change.

It is now not possible to switch the Digistat OFF using the + and- keys as previously described.

To enable the OFF function return to option 08 and select ON. Press > to accept change.

Option 09 How to lock the key pad - Access Protection Lock.

The access protection lock allows you to lock the Digistat Optimiser so that it cannot have any adjustments.

The default is OFF mode allowing you to adjust the Digistat.

To Lock the Digistat settings enter the User Options Menu Option 09 and select On and press > to accept.

Once the User Options Menu is exited all buttons will be locked.

To switch off the Protection Lock enter the User Menu and change to OFF. Press > to accept.

Once the User Menu is exited all buttons will be free to adjust.

NOTE: To exit User Options press < and > simultaneously for 3 seconds.

Special Note:

The following only applies when the Intelligent delayed start feature is enabled.

Ask your installer for details

When the delay period is operating indicated by the flame symbol flashing, pressing any button returns the DT10RF Programmer/Optimising Programmer to auto mode allowing normal button operation until the next time/temperature event, when it will resume the delay start mode or follows the Holiday, Manual, Override or Off modes as selected.



Changes to the installer options and pre-set programmes must be made with the flame symbol not flashing

What is Intelligent delayed start.

The Intelligent Delayed Start is an energy saving feature which automatically reduces the warm up time for the heating system.

As the weather becomes milder, Intelligent Start will delay the heating start times so that the fuel is not wasted bringing the room up to temperature earlier than necessary.

NOTE: See page 13 for further information and set up details.

RECEIVER

OPERATING CONTROLS

Large or Small Receiver

The Receiver provides the link with the room Programmer /Thermostat.

The Receiver indicates when heat is demanded with a green light and confirms the RF link with a flashing red light.

The heating can be switched ON or OFF at this unit, overriding the room Programmer.

Pressing OVERRIDE will change the state of the appliance, turning it OFF if it is ON or ON if it is OFF.

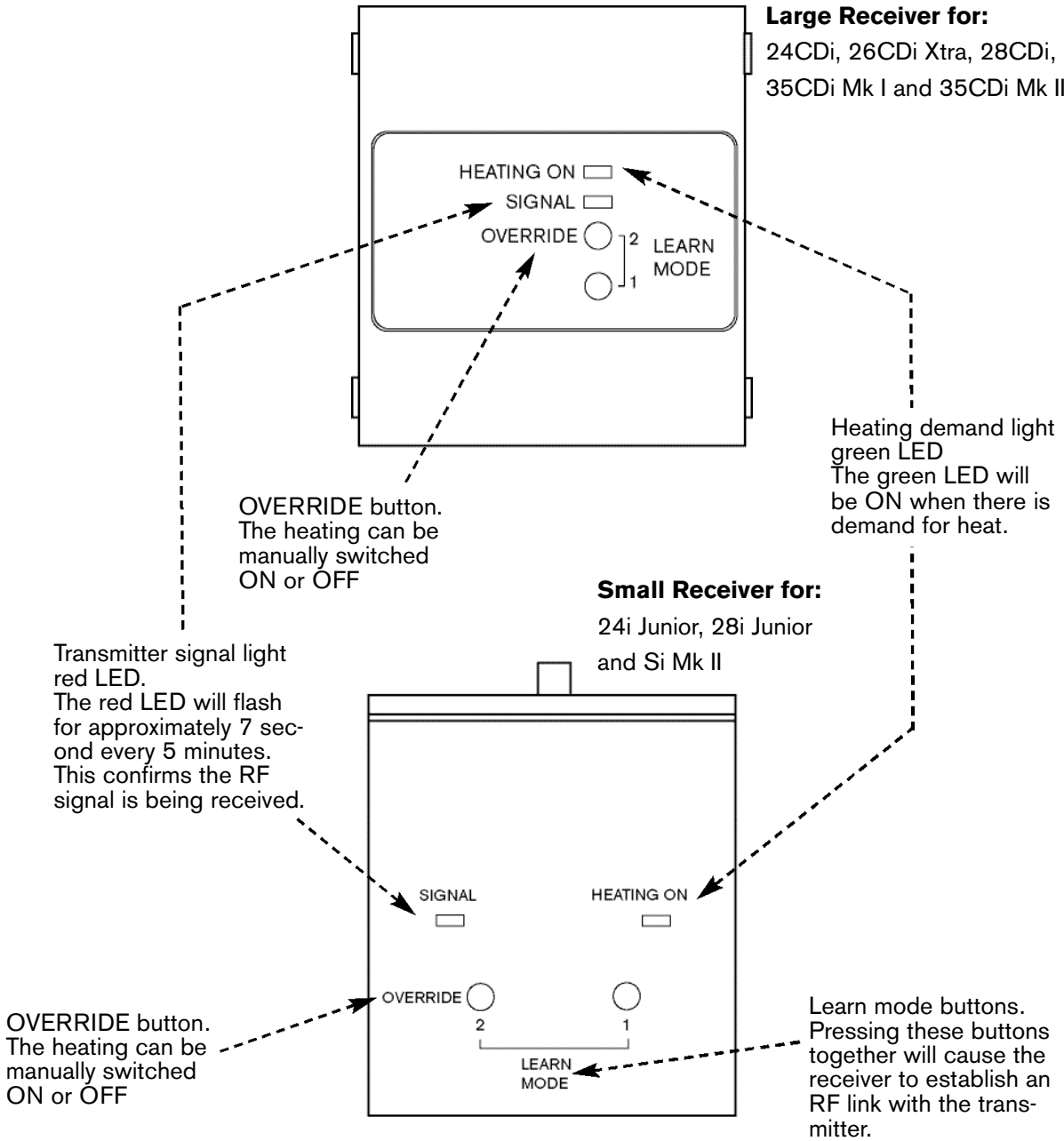

RECEIVER INSTALLATION

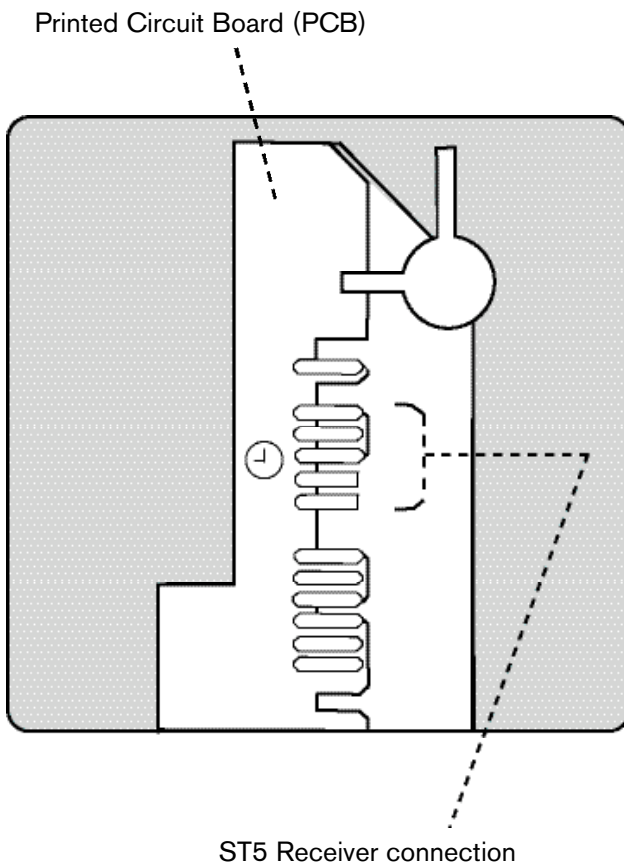

**DANGER: 230 VOLTS
DO NOT TOUCH THE
ELECTRICAL COMPONENTS
OR CIRCUITS**

**CAUTION:
ISOLATE THE MAINS ELECTRICITY
SUPPLY BEFORE STARTING ANY
WORK AND OBSERVE ALL RELEVANT
SAFETY PRECAUTIONS**

**OBSERVE ELECTRO-STATIC
DISCHARGE PRECAUTIONS.
DO NOT TOUCH THE PCB CIRCUIT**

NOTE: THIS ACCESSORY MUST BE FITTED BY A COMPETENT PERSON. FAILURE TO COMPLY COULD LEAD TO PROSECUTION.

1. Remove the blanking plate from the fascia by gently pulling the plate towards you to release the tabs.
2. Present the receiver up to the fascia, plug the connector onto the PCB as shown in the figure below. Ensure the connector is pushed firmly home.
3. Introduce the receiver tabs into the slots in the fascia.
Ensure that the lead is not trapped and then push the receiver into place to secure.

Location and mounting

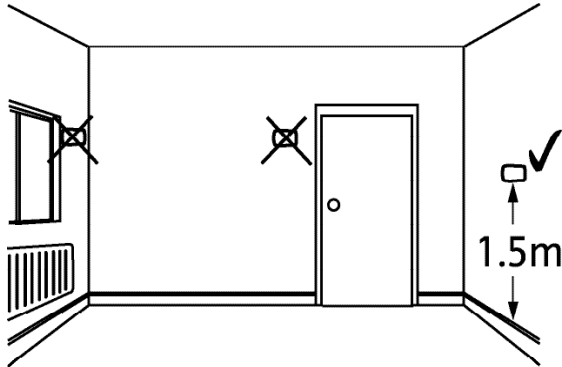

Location

The Digistat is a radio frequency device and for best performance should be mounted in an open space, no closer than 30cm to any metal objects, including wall boxes.

Mount on a wall, which is not subject to direct sunlight or draughts. Preferably mount on an inside wall about 1.5m (5ft) above the floor, away from the direct influence of radiators or other appliances giving off heat.

Mounting the digistat

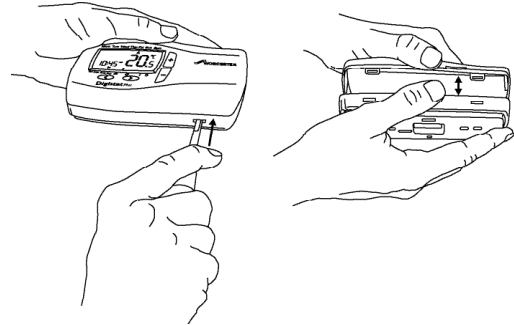

1. Remove the front cover using a flat screwdriver and separate from back plate.

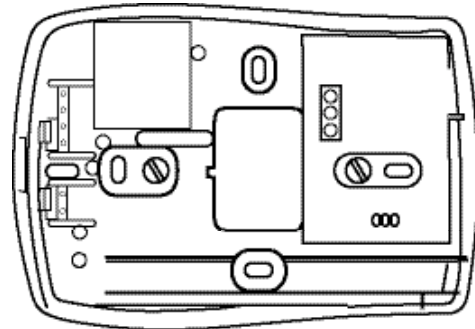

2. Fix the back plate directly onto the wall using suitable wall plugs and screws.

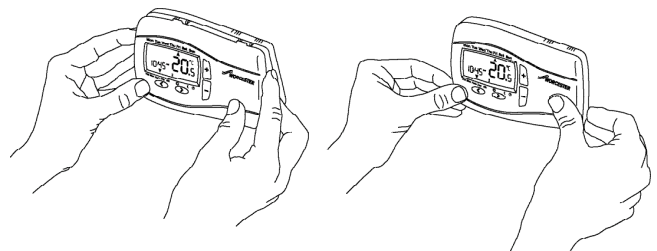

3. Replace the front cover by locating in position and pushing fully onto the back cover.

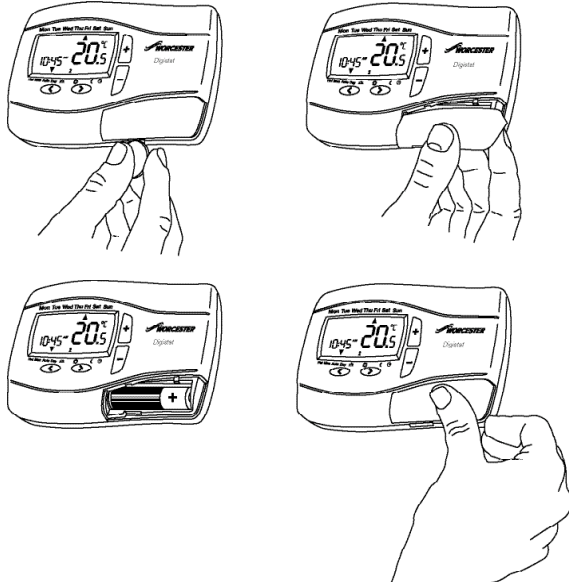

4. Remove the battery cover using a coin (Fig 4).
5. Install the 2 AA batteries provided (Fig 5).
6. Replace battery cover (fig 6).

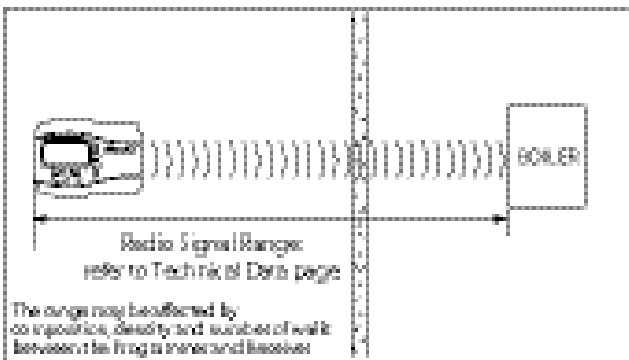

7. The Digistat is now installed and will automatically start to control the room temperature according to the pre-set program 1 as shown on page 8. The display shows the correct time and date which is automatically set together with the actual room temperature.

Receiver set up:

To set up the radio frequency (RF) link, the receiver must be put into the LEARN MODE.

To set up the RF link, proceed as follows:

1. Press the OVERRIDE button until the green light is ON, the appliance is now running in central heating mode.
2. To enter the LEARN MODE press and hold both buttons 1 and 2. The red light should flash for two seconds and then go out, this signifies that the receiver is in the LEARN MODE, release both buttons.
3. The red and green lights should both be ON.

Transmitter set up:

1. Take the Digistat Programmer unit and stand approximately two metres away from the boiler.
2. Remove the battery cover and fit the batteries. The red light on the receiver should flash for seven seconds, this confirms that the RF signal is being sent and received. After seven seconds the red light will stop flashing and the green light will come ON.

The Digistat Programmer is now linked to the receiver on the boiler.

Installer Options

If you wish to change any of the Installer Options as shown below, enter the Installer Option Menu from Auto mode by pressing < and + simultaneously for 5 seconds.

Pressing < and + again for 5 seconds will exit the Menu and return to Auto mode.

Once the Installer Options screen has been selected, the < and > buttons allow you to scroll through the Menu (shown below). The + and - allow you to change values. Once a value has been changed pressing > before exiting the Menu will save the new setting. (The figure below shows Option 02 OFF).

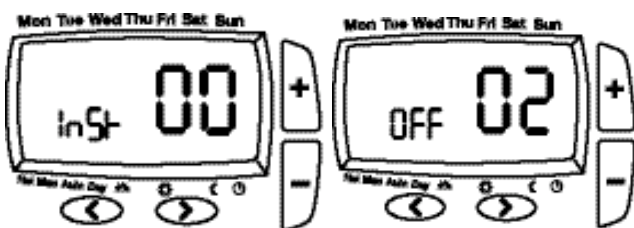

Installer Options	Function	Select Option		Default
02	Freeze protection	On	Off	On
04	Low Set Point C	5	High Limit	5
05	High Set Point C	Low Limit	32	32
06	Delayed Start (Energy saving feature)	On	Off	Off
10	System protection	On	Off	Off
11	System protection time (Mins)	1	5	3

Option 02 - Freeze Protection

Freeze protection will switch on the heating if the room temperature falls to 5°C and will then control the temperature at 7°C even if the Digistat is in OFF mode.

The Freeze Protection default in ON.

To switch off the Freeze Protection mode enter the Installer Options Menu (Refer to Installer Options 02) and change to OFF. Press > to accept.

Option 04 & 05 - Low and High Limit set points.

The user temperature set points defaults are High 32°C and Low 5°C, to change these limits enter the Installer Options Menu (Refer to Installer Options 04 & 05).

Option 06 - Intelligent Delayed Start (Energy saving feature).

The Intelligent Delayed Start is an energy saving feature which automatically reduces the warm up time for the heating system.

If enabled, the start time should be set an hour earlier than the time you want the property to reach the set temperature.

Intelligent Start will delay that start time, by an amount that it has calculated based on the actual and set temperature.

As the weather becomes milder, the start time is delayed, so that fuel is not wasted bringing the room up to temperature earlier than necessary.

The Digistat calculates approximately 10 minutes to raise the temperature by 1°C, up to a maximum of 6°C.

Note:

Intelligent Delayed Start only applies in Auto mode. Intelligent Delayed Start default is in OFF mode. To switch ON Intelligent Delayed Start enter the Installer Options Menu (see Installer Options 06).

Note:

The Intelligent Delayed start option is not suitable for underfloor application. Ensure Installer option 06 is set to OFF before final commissioning for underfloor application.

Special Note:

If the Intelligent delayed start feature is enabled, (Off changed to On in Installer option 06), please inform the end user of this feature.

The following special note has been added to the user instruction to explain the adjustment requirement:

When the delay period is operating indicated by the flame symbol flashing, pressing any button returns the Digistat to auto mode allowing normal button operation until the next time/ temperature event, when it will resume the delay start mode or follows the Holiday, Manual, Override or Off modes as selected.

Changes to the installer options and pre-set programmes must be made with the flame symbol not flashing.



Option 10 - System Protection

In some heating systems there may be a requirement to protect the system by operating it once a day, for a given period.

If system protection is selected the system will be operated for a period as shown in system protection time (mins).

System protection time is every day at 10.00am.

System protection default is OFF.

To enable the system protection mode enter the Installer Options Menu (Refer to Installer Option 10).

Option 11 - System Protection time (mins).

System protection time can be set between 1 and 5 minutes (default 3 minutes).

To change this once a day on time enter the Installer Options Menu (Refer to Installer Option 11).

How do I know when to change the batteries.

When the batteries start to run low a battery icon will flash in the display, to indicate "low battery" during this time the Digistat will function normally.



Replace with 2 x 1.5V (AA) Alkaline batteries.

When the battery icon alone is shown in the display, the batteries are completely exhausted and the Digistat will cease to function. Re-activate by replacing the batteries. The RF link will automatically be re-established.



How to replace the batteries

Remove the battery cover using a coin. Replace the spent batteries with 2 x 1.5V (AA) Alkaline batteries ensuring correct orientation. Replace the battery cover pressing fully home.

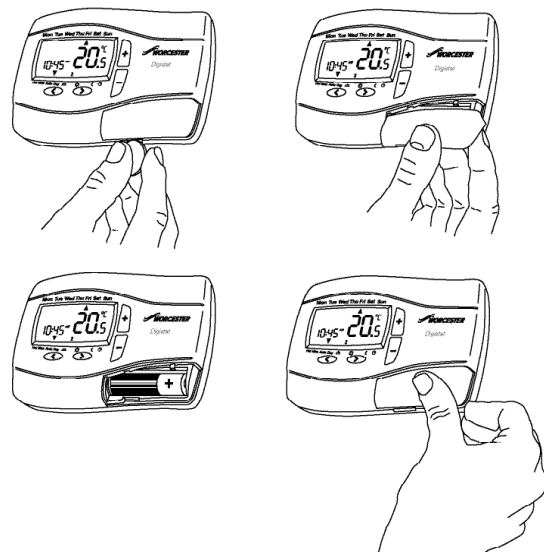

DIGISTAT / DT10RF RECEIVER
MAINTENANCE

Digistat Programmer
Part number 7 716 114 461 0

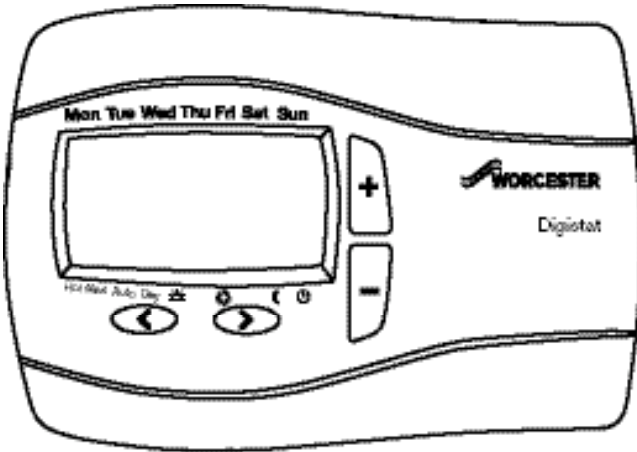

Maintenance:

The Transmitter (Digistat Programmer or Optimising Programmer) requires no maintenance. The outer casing can be wiped clean using a dry cloth. DO NOT use polish or detergents.

These units can not be serviced. Should the existing unit fail to function correctly, check:

- ▶ RF signal link is set up
 - ▶ Transmitter batteries are the correct type, fitted correctly and are not exhausted.
- Fit new batteries if in doubt.

Large Receiver
Part Number: 7 716 192 005 0

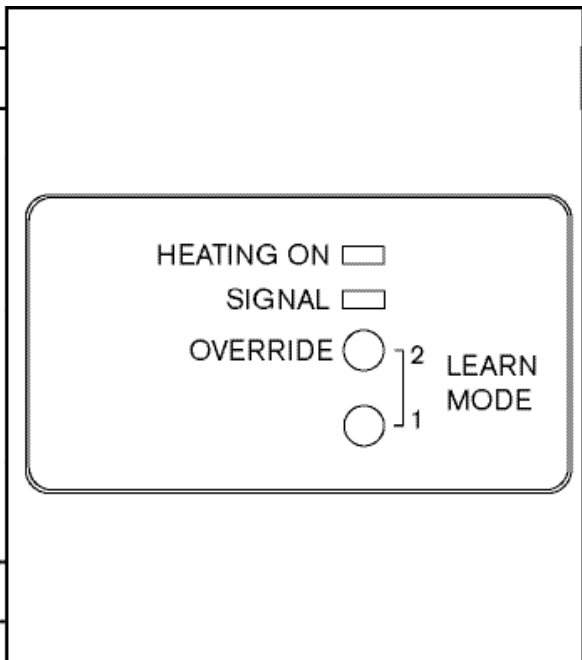

Small Receiver
Part Number: 8 716 105 129 0

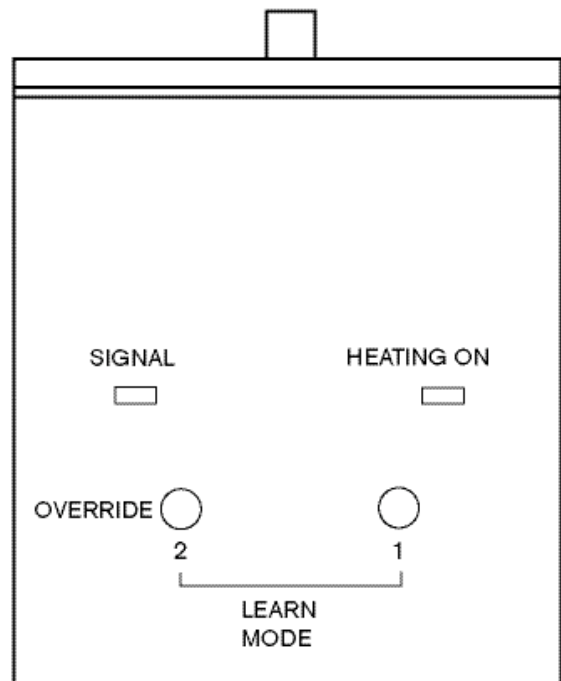

OPERATING AND INSTALLATION INSTRUCTIONS

Worcester, Bosch Group

Cotswold Way, Warndon, Worcester WR4 9SW.

Tel. 01905 754624 Fax. 01905 754619

www.worcester-bosch.co.uk

Worcester Bosch Group is a trading name of BBT Thermotechnology UK Ltd.

8 716 114 518a (09.07) 06515048001

CONTACT INFORMATION

WORCESTER, BOSCH GROUP:

TECHNICAL: 08705 266241

SERVICE: 08457 256206

SPARES: 01905 752571

LITERATURE: 01905 752556

TRAINING: 01905 752526

SALES: 01905 752640

WEBSITE: www.worcester-bosch.co.uk



WORCESTER
Bosch Group